

**M12 female 0° shielded B-cod. with cable, Profibus**

PVC 1x2xAWG24 shielded vt UL/CSA 5m

PROFIBUS

Female straight

M12, 2-pole

B-coded

shielded

Plastic housings with good resistance against chemicals and oils.

The resistance to aggressive media should be individually tested for your application. Further details on request.

Further cable lengths on request.

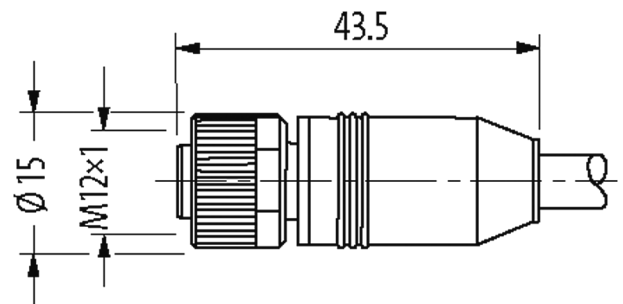
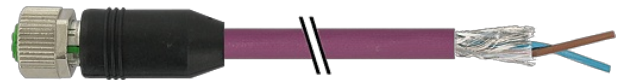
**Illustration**

Female



Product may differ from Image

**Approvals**

\* only for products with UL/CSA approved cable

cCSAus

**More Info**

**Form**

Form 14061

**Cables**No./diameter of wires 1 x 2 x 0.25 mm<sup>2</sup>

Wire isolation PE (rd, gn)

C-track properties 2 Mio.

Material (jacket) PVC (UL)

Outer Ø 7.8 mm ±5%

Bend radius (moving) 12 x outer Ø

Temperature range (fixed) -25...+70 °C

Temperature range (mobile) -20...+50 °C

Cable identification 850

Cable weight [g/m] 75,90

Material (wire) Cu wire, bare

Resistor (core) max. 68 Ω/km (20 °C)

Single wire Ø (core) 0.13 mm

Construction (core) 19 x 0.13 mm

Diameter (core) 1 x 2 x 0.25 mm<sup>2</sup>

AWG similar to AWG 24

Material (wire isolation) PE

Wire-Ø incl. isolation 2.55 mm ±5%

Color/numbering of wires rd, gn

Shield yes

min. 70%

Material (jacket) PVC

Outer-Ø (jacket) 7.8 mm ±5%

Color (jacket) violet

Nominal voltage 30 V AC

Test voltage 1.5 kV

Temperature range (fixed) -25...+70 °C

Temperature range (mobile) -20...+50 °C

Bend radius (fixed) 7.5 x outer Ø

Bend radius (moving) 12 x outer Ø

No. of bending cycles (C-track) max. 2 Mio. (25 °C)

Traversing distance (C-track) max. 5 m (horizontal)

Travel speed (C-track) max. 3 m/s

Acceleration (C-track) max. 5 m/s<sup>2</sup>

Jacket Color violet

**Technical Data**

Operating voltage max. 60 V AC/DC

Operating voltage (only UL listed) max. 30 V AC/DC

Rated surge voltage 1.5 kV

Operating current per contact max. 4 A

Material group IEC 60664-1, category I

Coding B-coded

Locking of ports Screw thread (M12x1 mm) recommended torque 0.6 Nm, self-securing

Compression gland	M12 (SW13)
Protection	IP65, IP66K, IP67 inserted and tightened (EN 60529)
Locking material	Zinc die casting, matte nickel plated
Material	PUR

**General data**

Standards	DIN EN 61076-2-101 (M12)
Pollution Degree	3
Stripping length (jacket)	20 mm
Temperature range	-25...+85 °C, depending on cable quality

**Commercial data**

country of origin	DE
customs tariff number	85444290
EAN	4048879464888
eClass	27061801
Packaging unit	1